

NLX2GU04

Dual Unbuffered Inverter

The NLX2GU04 MiniGate™ is an advanced high-speed CMOS dual unbuffered inverter in ultra-small footprint.

This device is well suited for use in oscillator, pulse-shaping and high input impedance amplifier applications. For digital applications, the NLX2G04 is recommended.

The NLX2GU04 input and output structures provide protection when voltages up to 7.0 V are applied, regardless of the supply voltage.

Features

- Designed for 1.65 V to 5.5 V V_{CC} Operation
- Unbuffered for Crystal Oscillator and Analog Applications
- 16 mA Balanced Output Source and Sink Capability
- Balanced Propagation Delays
- Overvoltage Tolerant (OVT) Input and Output Pins
- Ultra-Small Packages
- These are Pb-Free Devices

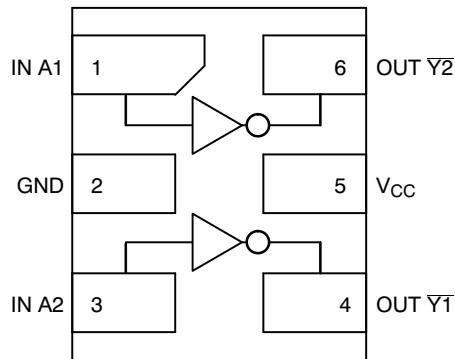

Figure 1. Pinout (Top View)

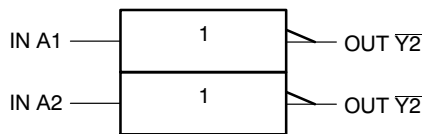

Figure 2. Logic Symbol



ON Semiconductor®

<http://onsemi.com>

MARKING DIAGRAMS

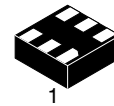

ULLGA6
1.0 x 1.0
CASE 613AD

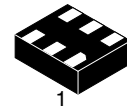

ULLGA6
1.2 x 1.0
CASE 613AE

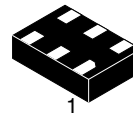

ULLGA6
1.45 x 1.0
CASE 613AF



L = Device Marking
M = Date Code

PIN ASSIGNMENT

| | |
|---|----------------|
| 1 | IN A1 |
| 2 | GND |
| 3 | IN A2 |
| 4 | OUT $\bar{Y}2$ |
| 5 | V_{CC} |
| 6 | OUT $\bar{Y}1$ |

FUNCTION TABLE

| A | \bar{Y} |
|---|-----------|
| L | H |
| H | L |

ORDERING INFORMATION

See detailed ordering and shipping information in the package dimensions section on page 5 of this data sheet.

NLX2GU04

MAXIMUM RATINGS

| Symbol | Parameter | Value | Unit |
|----------------------|--|----------------------|------|
| V _{CC} | DC Supply Voltage | -0.5 to +7.0 | V |
| V _{IN} | DC Input Voltage | -0.5 to +7.0 | V |
| V _{OUT} | DC Output Voltage | -0.5 to +7.0 | V |
| I _{IK} | DC Input Diode Current V _{IN} < GND | -50 | mA |
| I _{OK} | DC Output Diode Current V _{OUT} < GND | -50 | mA |
| I _O | DC Output Source/Sink Current | ±50 | mA |
| I _{CC} | DC Supply Current Per Supply Pin | ±100 | mA |
| I _{GND} | DC Ground Current per Ground Pin | ±100 | mA |
| T _{STG} | Storage Temperature Range | -65 to +150 | °C |
| T _L | Lead Temperature, 1 mm from Case for 10 Seconds | 260 | °C |
| T _J | Junction Temperature Under Bias | 150 | °C |
| MSL | Moisture Sensitivity | Level 1 | |
| F _R | Flammability Rating Oxygen Index: 28 to 34 | UL 94 V-0 @ 0.125 in | |
| I _{LATCHUP} | Latchup Performance Above V _{CC} and Below GND at 125 °C (Note 5) | ±500 | mA |

Stresses exceeding Maximum Ratings may damage the device. Maximum Ratings are stress ratings only. Functional operation above the Recommended Operating Conditions is not implied. Extended exposure to stresses above the Recommended Operating Conditions may affect device reliability.

1. Measured with minimum pad spacing on an FR4 board, using 10 mm-by-1 inch, 2 ounce copper trace no air flow.
2. Tested to EIA/JESD22-A114-A.
3. Tested to EIA/UESD22-A115-A.
4. Tested to JESD22-C101-A.
5. Tested to EIA / JESD78.

RECOMMENDED OPERATING CONDITIONS

| Symbol | Parameter | Min | Max | Unit |
|------------------|--|--------|-----------|------|
| V _{CC} | Positive DC Supply Voltage | 1.65 | 5.5 | V |
| V _{IN} | Digital Input Voltage | 0 | 5.5 | V |
| V _{OUT} | Output Voltage | 0 | 5.5 | V |
| T _A | Operating Free-Air Temperature | -55 | +125 | °C |
| Δt/ΔV | Input Transition Rise or Fall Rate V _{CC} = 3.3 V ± 0.3 V V _{CC} = 5.0 V ± 0.5 V | 0 0 | 100 20 | ns/V |

NLX2GU04

DC ELECTRICAL CHARACTERISTICS

| Symbol | Parameter | Conditions | V _{CC} (V) | T _A = 25 °C | | | T _A = +85°C | | T _A = -55°C to +125°C | | Unit |
|--------------------------|----------------------------------|---|---------------------|--|-----------------|--|--|--|--|--|------|
| | | | | Min | Typ | Max | Min | Max | Min | Max | |
| V _{IH} | Low-Level Input Voltage | | 1.65 2.3 to 5.5 | 0.85 x V _{CC} 0.80 x V _{CC} | | | 0.85 x V _{CC} 0.80 x V _{CC} | | 0.85 x V _{CC} 0.80 x V _{CC} | | V |
| V _{IL} | Low-Level Input Voltage | | 1.65 2.3 to 5.5 | | | 0.15 x V _{CC} 0.20 x V _{CC} | | 0.15 x V _{CC} 0.20 x V _{CC} | | 0.15 x V _{CC} 0.20 x V _{CC} | V |
| V _{OH} | High-Level Output Voltage | V _{IN} = V _{IH} or V _{IL} I _{OH} = -100 μA | 1.65 to 5.5 | V _{CC} - 0.1 | V _{CC} | | V _{CC} - 0.1 | | V _{CC} - 0.1 | | V |
| | | V _{IN} = V _{IH} or V _{IL} I _{OH} = -3 mA | 1.65 | 1.29 | 1.52 | | 1.29 | | 1.29 | | |
| | | I _{OH} = -4 mA | 2.3 | 1.9 | 2.1 | | 1.9 | | 1.9 | | |
| | | I _{OH} = -6 mA | 2.7 | 2.2 | 2.3 | | 2.2 | | 2.2 | | |
| | | I _{OH} = -8 mA | 3.0 | 2.4 | 2.6 | | 2.4 | | 2.4 | | |
| | | I _{OH} = -12 mA | 3.0 | 2.3 | 2.5 | | 2.3 | | 2.3 | | |
| I _{OH} = -16 mA | 4.5 | 3.8 | 4.0 | | 3.8 | | 3.8 | | | | |
| V _{OL} | Low-Level Output Voltage | V _{IN} = V _{IH} or V _{IL} I _{OL} = 50 μA | 1.65 to 5.5 | | | 0.1 | | 0.1 | | 0.1 | V |
| | | V _{IN} = V _{IH} or V _{IL} I _{OH} = 3 mA | 1.65 | | 0.08 | 0.24 | | 0.24 | | 0.24 | |
| | | I _{OH} = 4 mA | 2.3 | | 0.12 | 0.3 | | 0.3 | | 0.3 | |
| | | I _{OH} = 6 mA | 2.7 | | 0.2 | 0.4 | | 0.4 | | 0.4 | |
| | | I _{OH} = 8 mA | 3.0 | | 0.24 | 0.4 | | 0.4 | | 0.4 | |
| | | I _{OH} = 12 mA | 3.0 | | 0.36 | 0.55 | | 0.55 | | 0.55 | |
| I _{OH} = 16 mA | 4.5 | | 0.31 | 0.55 | | 0.55 | | 0.55 | | | |
| I _{IN} | Input Leakage Current | 0 ≤ V _{IN} ≤ 5.5 V | 0 to 5.5 | | | ±0.1 | | ±1.0 | | ±1.0 | μA |
| I _{OFF} | Power-Off Output Leakage Current | V _{OUT} = 5.5 V | 0 | | | 1.0 | | 10 | | 10 | μA |
| I _{CC} | Quiescent Supply Current | 0 ≤ V _{IN} ≤ V _{CC} | 5.5 | | | 1.0 | | 10 | | 10 | μA |

NLX2GU04

AC ELECTRICAL CHARACTERISTICS (Input $t_r = t_f = 3.0$ ns)

| Symbol | Parameter | V_{CC} (V) | Test Condition | $T_A = 25^\circ\text{C}$ | | | $T_A = -55^\circ\text{C}$ to $+125^\circ\text{C}$ | | Unit |
|--------------------------|---|--------------|--|--------------------------|-----|-----|---|-----|------|
| | | | | Min | Typ | Max | Min | Max | |
| t_{PLH} , t_{PHL} | Propagation Delay, Input A to Output Y | 1.65 to 1.95 | $R_L = 1\text{ M}\Omega$, $C_L = 15\text{ pF}$ | 1.5 | 1.8 | 5.5 | 1.5 | 11 | ns |
| | | 2.3 to 2.7 | $R_L = 1\text{ M}\Omega$, $C_L = 15\text{ pF}$ | 1.2 | 3.3 | 5.7 | 1.2 | 6.3 | |
| | | 3.0 to 3.6 | $R_L = 1\text{ M}\Omega$, $C_L = 15\text{ pF}$ | 0.8 | 2.7 | 4.1 | 0.8 | 4.5 | |
| | | | $R_L = 500\ \Omega$, $C_L = 50\text{ pF}$ | 1.2 | 4.0 | 6.4 | 1.2 | 7.0 | |
| | | 4.5 to 5.5 | $R_L = 1\text{ M}\Omega$, $C_L = 15\text{ pF}$ | 0.5 | 2.2 | 3.3 | 0.5 | 3.6 | |
| | | | $R_L = 500\ \Omega$, $C_L = 50\text{ pF}$ | 0.8 | 3.4 | 5.6 | 0.8 | 6.2 | |
| C_{IN} | Input Capacitance | 5.5 | $V_{IN} = 0\text{ V}$ or V_{CC} | | 7 | | | | pF |
| C_{OUT} | Output Capacitance | 5.5 | $V_{IN} = 0\text{ V}$ or V_{CC} | | 8 | | | | pF |
| C_{PD} | Power Dissipation Capacitance (Note 6) | 5.5 | 10 MHz $V_{IN} = 0\text{ V}$ or V_{CC} | | 25 | | | | pF |

6. C_{PD} is defined as the value of the internal equivalent capacitance which is calculated from the dynamic operating current consumption without load. Average operating current can be obtained by the equation $I_{CC(OPR)} = C_{PD} \cdot V_{CC} \cdot f_{in} + I_{CC}$. C_{PD} is used to determine the no-load dynamic power consumption: $P_D = C_{PD} \cdot V_{CC}^2 \cdot f_{in} + I_{CC} \cdot V_{CC}$.

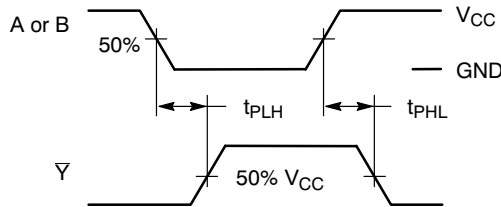
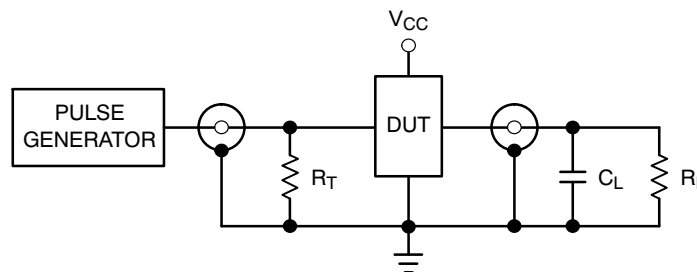

Figure 3. Switching Waveforms



$R_T = Z_{OUT}$ of pulse generator (typically 50 Ω)

Figure 4. Test Circuit

NLX2GU04

ORDERING INFORMATION

| Device | Package | Shipping† |
|-----------------|---------------------------------------|--------------------|
| NLX2GU04AMX1TCG | ULLGA6, 1.45 x 1.0, 0.5P (Pb-Free) | 3000 / Tape & Reel |
| NLX2GU04BMX1TCG | ULLGA6, 1.2 x 1.0, 0.4P (Pb-Free) | 3000 / Tape & Reel |
| NLX2GU04CMX1TCG | ULLGA6, 1.0 x 1.0, 0.35P (Pb-Free) | 3000 / Tape & Reel |

†For information on tape and reel specifications, including part orientation and tape sizes, please refer to our Tape and Reel Packaging Specifications Brochure, BRD8011/D.

NLX2GU04

PACKAGE DIMENSIONS

ULLGA6 1.0x1.0, 0.35P
CASE 613AD-01
ISSUE A



NOTES:

1. DIMENSIONING AND TOLERANCING PER ASME Y14.5M, 1994.
2. CONTROLLING DIMENSION: MILLIMETERS.
3. DIMENSION b APPLIES TO PLATED TERMINAL AND IS MEASURED BETWEEN 0.15 AND 0.30 mm FROM THE TERMINAL TIP.
4. A MAXIMUM OF 0.05 PULL BACK OF THE PLATED TERMINAL FROM THE EDGE OF THE PACKAGE IS ALLOWED.

| MILLIMETERS | | |
|-------------|----------|------|
| DIM | MIN | MAX |
| A | --- | 0.40 |
| A1 | 0.00 | 0.05 |
| b | 0.12 | 0.22 |
| D | 1.00 BSC | |
| E | 1.00 BSC | |
| e | 0.35 BSC | |
| L | 0.25 | 0.35 |
| L1 | 0.30 | 0.40 |

MOUNTING FOOTPRINT SOLDERMASK DEFINED*

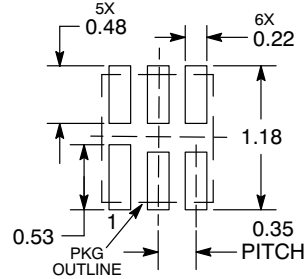

DIMENSIONS: MILLIMETERS

*For additional information on our Pb-Free strategy and soldering details, please download the ON Semiconductor Soldering and Mounting Techniques Reference Manual, SOLDERRM/D.

NLX2GU04

PACKAGE DIMENSIONS

ULLGA6 1.2x1.0, 0.4P
CASE 613AE-01
ISSUE A



NOTES:

1. DIMENSIONING AND TOLERANCING PER ASME Y14.5M, 1994.
2. CONTROLLING DIMENSION: MILLIMETERS.
3. DIMENSION b APPLIES TO PLATED TERMINAL AND IS MEASURED BETWEEN 0.15 AND 0.30 mm FROM THE TERMINAL TIP.
4. A MAXIMUM OF 0.05 PULL BACK OF THE PLATED TERMINAL FROM THE EDGE OF THE PACKAGE IS ALLOWED.

| MILLIMETERS | | |
|-------------|----------|------|
| DIM | MIN | MAX |
| A | --- | 0.40 |
| A1 | 0.00 | 0.05 |
| b | 0.15 | 0.25 |
| D | 1.20 BSC | |
| E | 1.00 BSC | |
| e | 0.40 BSC | |
| L | 0.25 | 0.35 |
| L1 | 0.35 | 0.45 |

**MOUNTING FOOTPRINT
SOLDERMASK DEFINED***

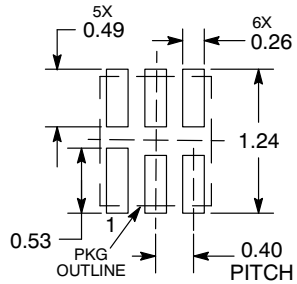

DIMENSIONS: MILLIMETERS

*For additional information on our Pb-Free strategy and soldering details, please download the ON Semiconductor Soldering and Mounting Techniques Reference Manual, SOLDERRM/D.

NLX2GU04

PACKAGE DIMENSIONS

ULLGA6 1.45x1.0, 0.5P
CASE 613AF-01
ISSUE A

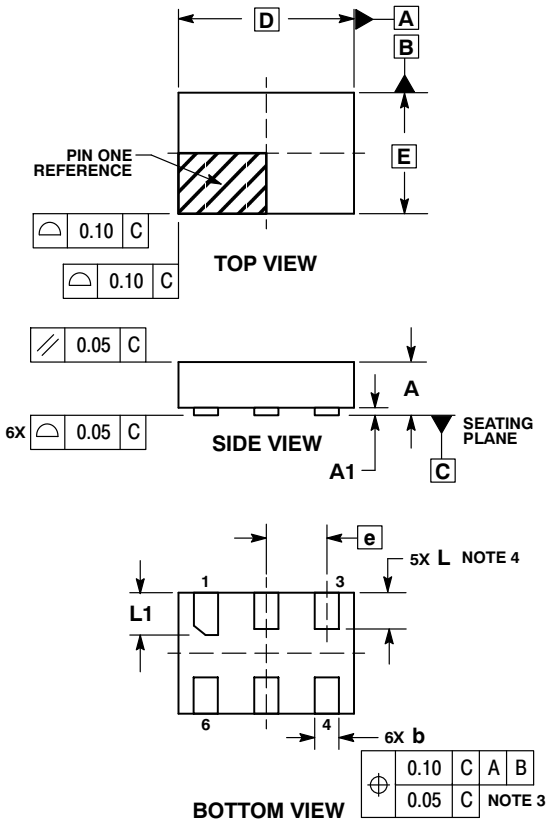

NOTES:

1. DIMENSIONING AND TOLERANCING PER ASME Y14.5M, 1994.
2. CONTROLLING DIMENSION: MILLIMETERS.
3. DIMENSION b APPLIES TO PLATED TERMINAL AND IS MEASURED BETWEEN 0.15 AND 0.30 mm FROM THE TERMINAL TIP.
4. A MAXIMUM OF 0.05 PULL BACK OF THE PLATED TERMINAL FROM THE EDGE OF THE PACKAGE IS ALLOWED.

| DIM | MILLIMETERS | |
|-----|-------------|------|
| | MIN | MAX |
| A | --- | 0.40 |
| A1 | 0.00 | 0.05 |
| b | 0.15 | 0.25 |
| D | 1.45 BSC | |
| E | 1.00 BSC | |
| e | 0.50 BSC | |
| L | 0.25 | 0.35 |
| L1 | 0.30 | 0.40 |

MOUNTING FOOTPRINT SOLDERMASK DEFINED*

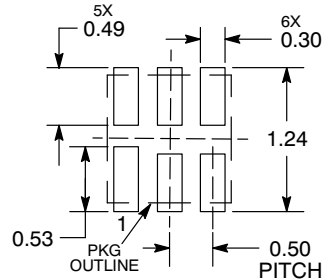

DIMENSIONS: MILLIMETERS

*For additional information on our Pb-Free strategy and soldering details, please download the ON Semiconductor Soldering and Mounting Techniques Reference Manual, SOLDERRM/D.

MiniGate is a trademark of Semiconductor Components Industries, LLC (SCILLC).

ON Semiconductor and are registered trademarks of Semiconductor Components Industries, LLC (SCILLC). SCILLC reserves the right to make changes without further notice to any products herein. SCILLC makes no warranty, representation or guarantee regarding the suitability of its products for any particular purpose, nor does SCILLC assume any liability arising out of the application or use of any product or circuit, and specifically disclaims any and all liability, including without limitation special, consequential or incidental damages. "Typical" parameters which may be provided in SCILLC data sheets and/or specifications can and do vary in different applications and actual performance may vary over time. All operating parameters, including "Typicals" must be validated for each customer application by customer's technical experts. SCILLC does not convey any license under its patent rights nor the rights of others. SCILLC products are not designed, intended, or authorized for use as components in systems intended for surgical implant into the body, or other applications intended to support or sustain life, or for any other application in which the failure of the SCILLC product could create a situation where personal injury or death may occur. Should Buyer purchase or use SCILLC products for any such unintended or unauthorized application, Buyer shall indemnify and hold SCILLC and its officers, employees, subsidiaries, affiliates, and distributors harmless against all claims, costs, damages, and expenses, and reasonable attorney fees arising out of, directly or indirectly, any claim of personal injury or death associated with such unintended or unauthorized use, even if such claim alleges that SCILLC was negligent regarding the design or manufacture of the part. SCILLC is an Equal Opportunity/Affirmative Action Employer. This literature is subject to all applicable copyright laws and is not for resale in any manner.

PUBLICATION ORDERING INFORMATION

LITERATURE FULFILLMENT:
Literature Distribution Center for ON Semiconductor
P.O. Box 5163, Denver, Colorado 80217 USA
Phone: 303-675-2175 or 800-344-3860 Toll Free USA/Canada
Fax: 303-675-2176 or 800-344-3867 Toll Free USA/Canada
Email: orderlit@onsemi.com

N. American Technical Support: 800-282-9855 Toll Free
USA/Canada
Europe, Middle East and Africa Technical Support:
Phone: 421 33 790 2910
Japan Customer Focus Center
Phone: 81-3-5773-3850

ON Semiconductor Website: www.onsemi.com
Order Literature: <http://www.onsemi.com/orderlit>
For additional information, please contact your local Sales Representative